

2005-06-10
126 35 Hägersten
Midsommarv. 8-10
MDS AB. David Fock
Högtalare MDS AC25
F-3dB vid 47.7Hz materialtjocklek 22mm
i stora kammaren Spl: 129dB
2-kammarlåda 2 rör 70x ø103 mm

av Johan Lindberg.
Backlunds Ljudbyggeri. Programmering
Ritningen gjord med ProBox 2000 från

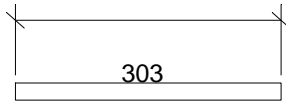

Djup 626

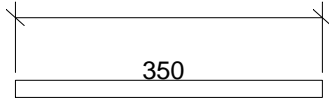

Djup 670

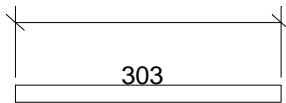

Djup 670

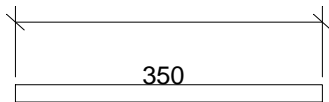

Djup 670

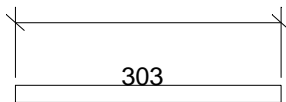

Djup 670

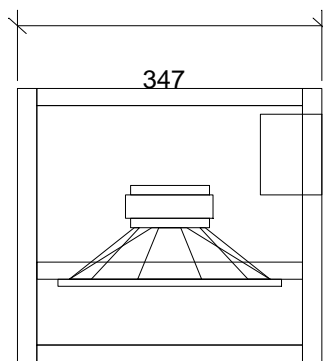
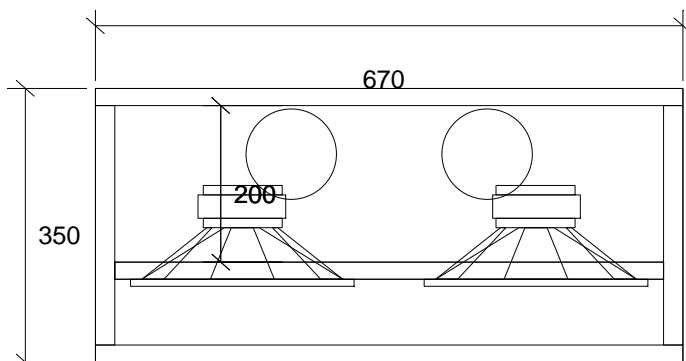
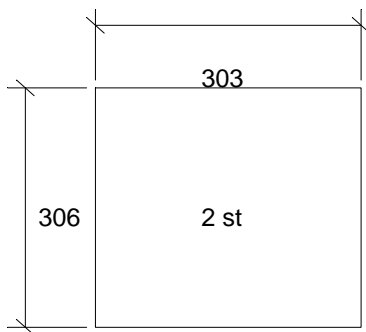

Genererat av ProBox 2000

Programmet från Backe & Johan

Beräkningen gjord av: David Fock på MDS AB 2005-06-10

Fabrikat: MDS

Vb1: 38 liter

Modell: AC25 10 tum

Vb2: 20 liter

Antal: 2

F-3dB: 47.7 Hz

Qts: .488

Fb1: 48 Hz

Vas: 57 liter

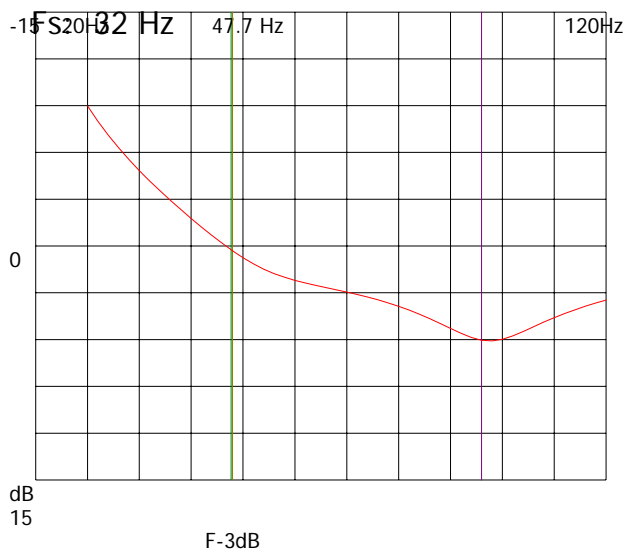

Portdia1: 10.3 cm

Antal: 2

Längd: 7 cm

Schematisk skiss lådtype: 5é ord. Hifi låda

Biltyp: Golf storlek
Musiktyp: Allt

(eventuellt fel antal högtalare.)

84% Funktion Spl: 129dB

