

2009-07-08
254 66
Garnisonsgatan 10
MDS Helsingborg. Jan Pålsson
Högtalare MDS Fanaticpower10
F-3dB vid 44.3Hz materialtjocklek 21mm
ø70 mm. Spl: 123dB
Basreflex totalvolym 28l. 1 rör 240x

av Johan Lindberg.
Backlunds Ljudbyggeri. Programmering
Ritningen gjord med ProBox 2000 från

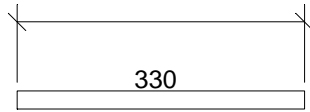

Djup 390

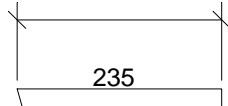

75°

Djup 390

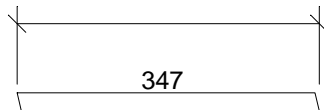

75°

Djup 390

75°

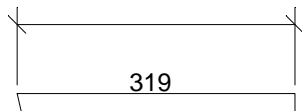

75°

Djup 390

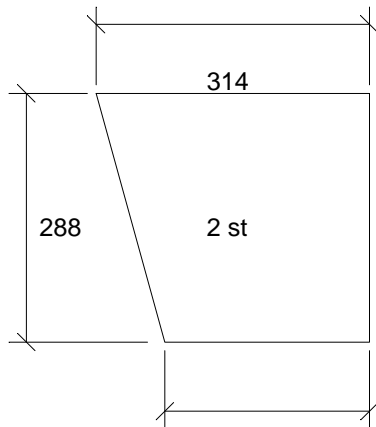

235

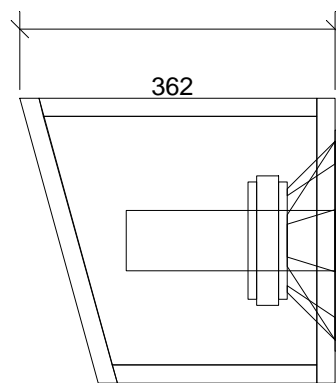
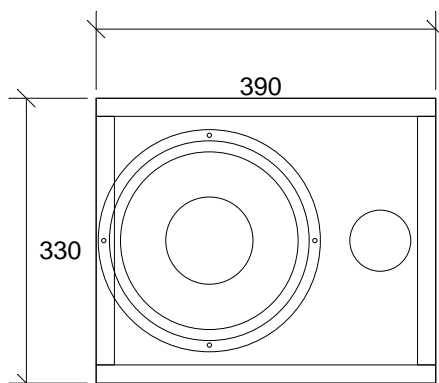

Genererat av ProBox 2000

Programmet från Backe & Johan

Beräkningen gjord av: Jan Pålsson på MDS Helsingborg 2009-07-08

Fabrikat: MDS

Vb1: 28 liter

Modell: Fanaticpower10 10 tum

Antal: 1

F-3dB: 44.3 Hz

Qts: .43

Fb1: 38 Hz

Vas: 55.67 liter

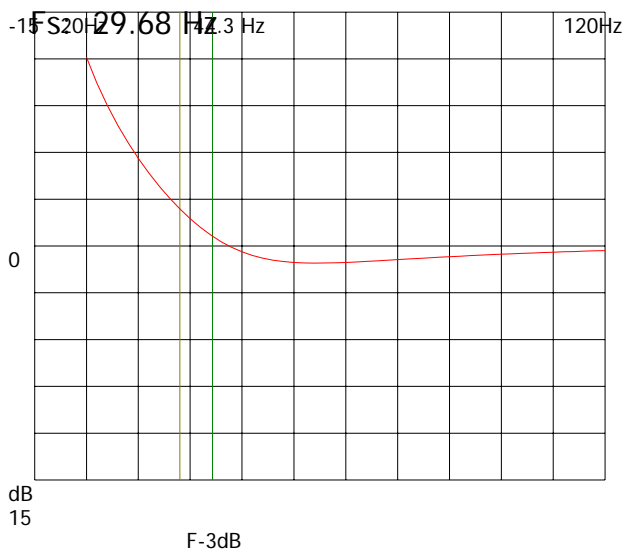

Portdia1: 7 cm

Antal: 1

Längd: 24 cm

Schematisk skiss lådtype: Basreflex

(eventuellt fel antal högtalare.)

Biltyp: Golf storlek

Musiktyp: Allt

69% Funktion Spl: 123dB

