

2009-07-08
254 66
Garnisonsgatan 10
MDS Helsingborg. Jan Pålsson
Högtalare MDS Fanaticpower10
F-3dB vid 36.8Hz materialtjocklek 21mm
.66 Spl: 125dB
Sluten låda totalvolym 83l. Qtc=

av Johan Lindberg.
Backlunds Ljudbyggeri. Programmering
Ritningen gjord med ProBox 2000 från

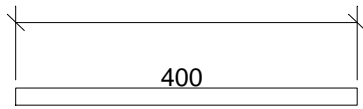

Djup 690

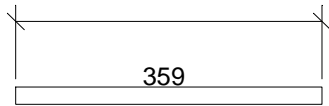

Djup 690

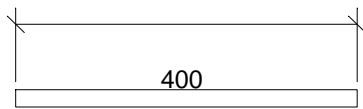

Djup 690

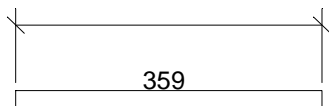

Djup 690

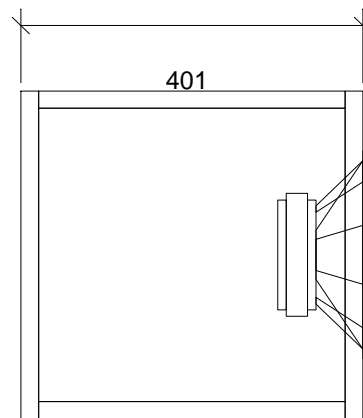
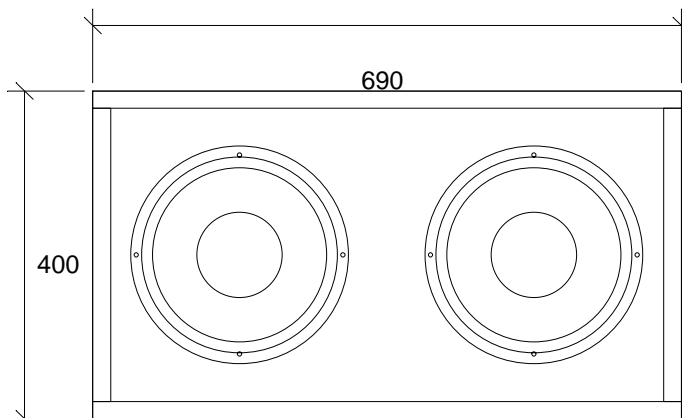
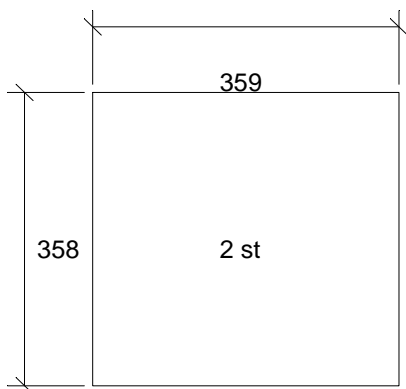

Genererat av ProBox 2000

Programmet från Backe & Johan

Beräkningen gjord av: Jan Pålsson på MDS Helsingborg 2009-07-08

Fabrikat: MDS

Vb1: 83 liter

Modell: Fanaticpower10 10 tum

Antal: 2

F-3dB: 36.8 Hz

Qts: .43

Fb1: 34 Hz

Vas: 55.67 liter

Qtc: .66

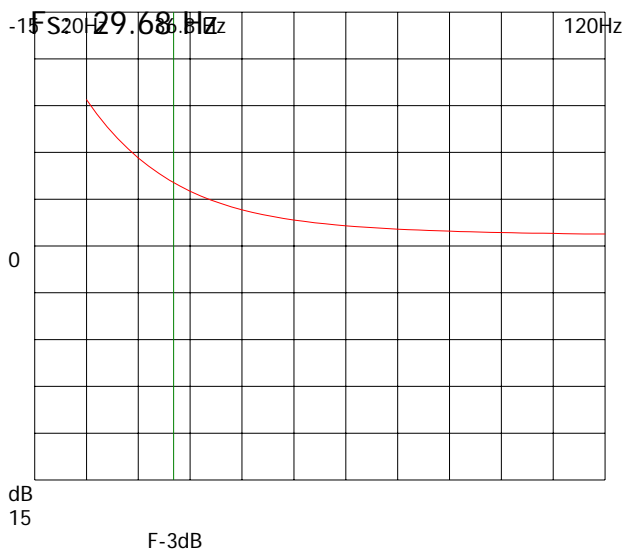

Schematisk skiss lådtype: Sluten

(eventuellt fel antal högtalare.)

Beräknad för litet rum

Musiktyp: Allt

56% Funktion Spl: 125dB

