

2005-06-10
126 35 Hägersten
Midsommarv. 8-10
MDS AB. David Fock
Högtalare MDS MDS FD10
F-3dB vid 34Hz materialtjocklek 22mm
.63 Spl: 119dB
Sluten låda totalvolym 35l. Qtc=

av Johan Lindberg.
Backlunds Ljudbyggeri. Programmering
Ritningen gjord med ProBox 2000 från

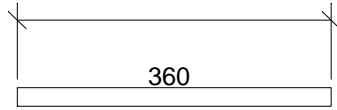

Djup 410

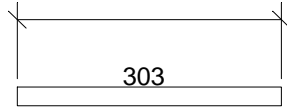

Djup 410

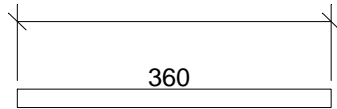

Djup 410

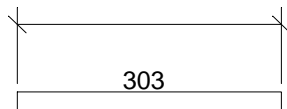

Djup 410

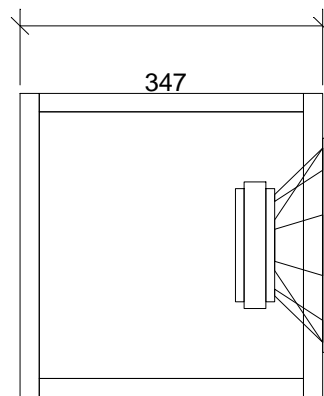
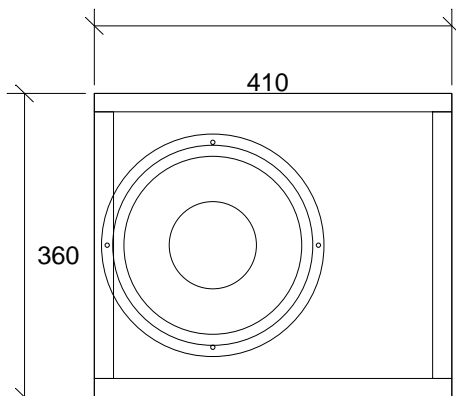
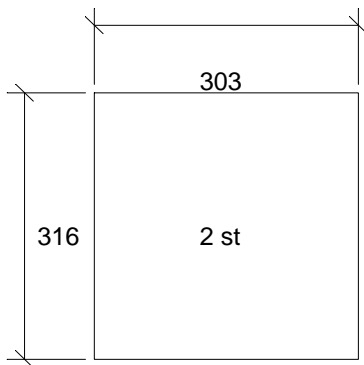

Genererat av ProBox 2000

Programmet från Backe & Johan

Beräkningen gjord av: David Fock på MDS AB 2005-06-10

Fabrikat: MDS

Vb1: 35 liter

Modell: MDS FD10 10 tum

Antal: 1

F-3dB: 34 Hz

Qts: .439

Fb1: 31 Hz

Vas: 36.439 liter

Qtc: .63

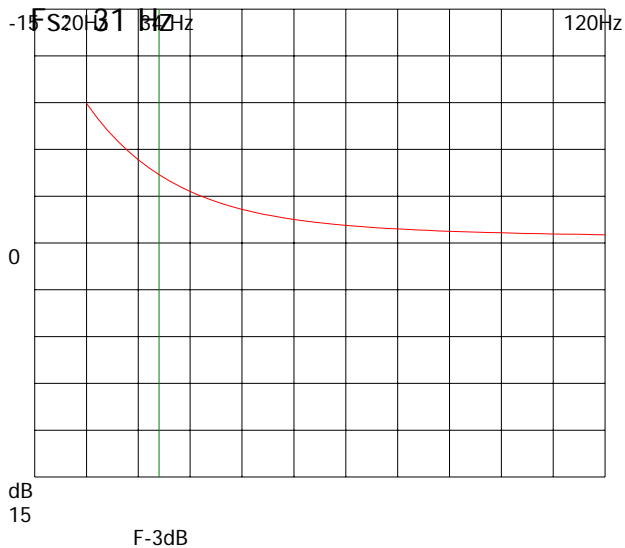

Schematisk skiss lådtype: Sluten

(eventuellt fel antal högtalare.)

Beräknad för litet rum

Musiktyp: Allt

54% Funktion Spl: 119dB

