

2005-06-10
126 35 Hägersten
Midsommarv. 8-10
MDS AB. David Fock
Högtalare MDS MDS FD12
F-3dB vid 45.5Hz materialtjocklek 22mm
ø103 mm. Spl: 131dB
Basreflex totalvolym 78l. 2 rör 390x

av Johan Lindberg.
Backlunds Ljudbyggeri. Programmering
Ritningen gjord med ProBox 2000 från

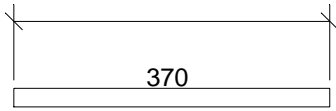

Djup 800

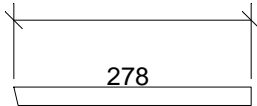

77°

Djup 800

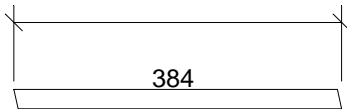

77°

Djup 800

77°

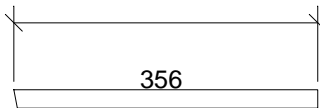

77°

Djup 800

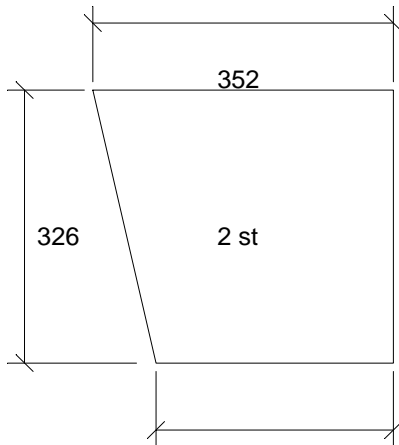

278

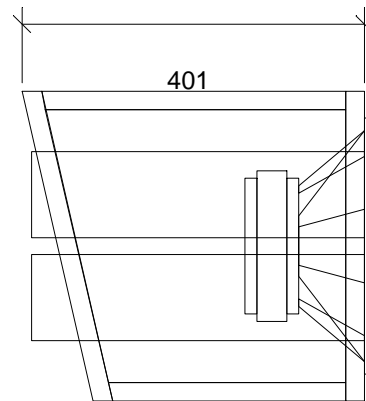
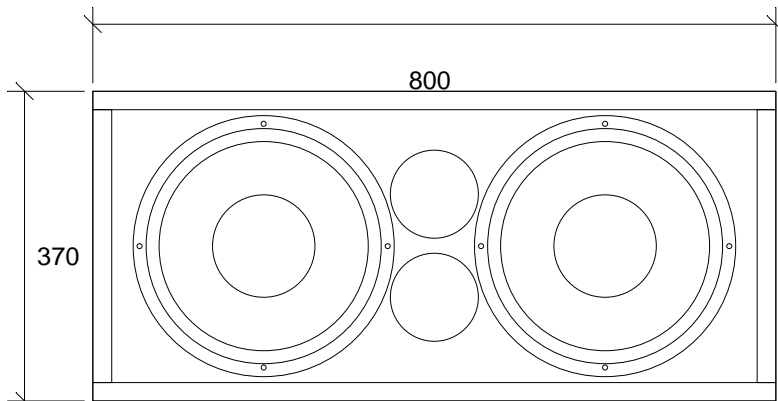

Genererat av ProBox 2000

Programmet från Backe & Johan

Beräkningen gjord av: David Fock på MDS AB 2005-06-10

Fabrikat: MDS

Vb1: 78 liter

Modell: MDS FD12 12 tum

Antal: 2

F-3dB: 45.5 Hz

Qts: .54

Fb1: 39 Hz

Vas: 79.548 liter

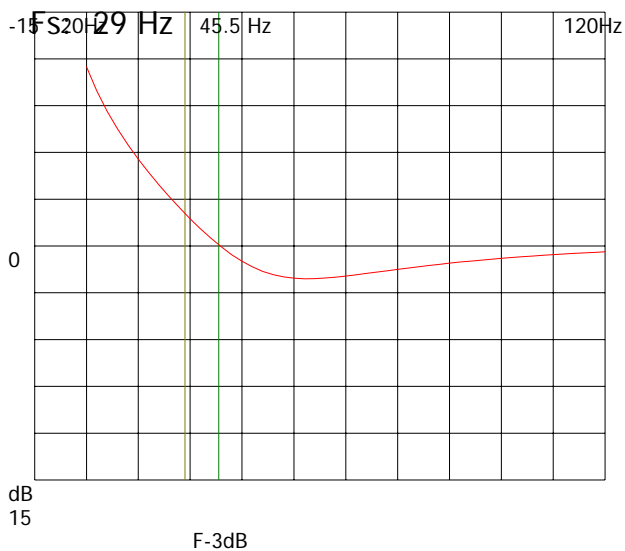

Portdia1: 10.3 cm

Antal: 2

Längd: 39 cm

Schematisk skiss lådtype: Basreflex

(eventuellt fel antal högtalare.)

Egen F-3db frekvens
Musiktyp: Allt

?% Funktion Spl: 131dB

