

2005-06-10  
126 35 Hägersten  
Midsommarv. 8-10  
MDS AB. David Fock  
Högtalare MDS MDS FD8  
F-3dB vid 38Hz materialtjocklek 22mm  
i stora kammaren Spl: 120dB  
2-kammarlåda 1 rör 110x ø70 mm

av Johan Lindberg.  
Backlunds Ljudbyggeri. Programmering  
Ritningen gjord med ProBox 2000 från

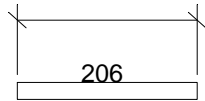

Djup 216

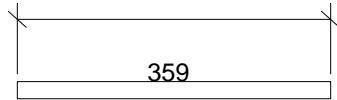

Djup 260

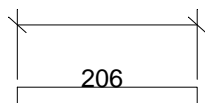

Djup 260

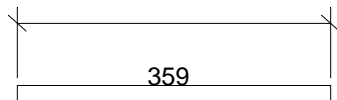

Djup 260

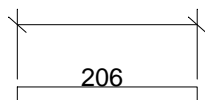

Djup 260

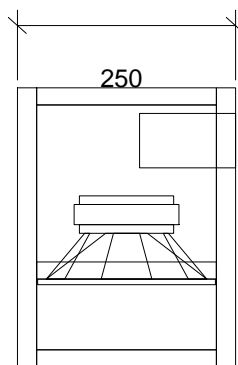
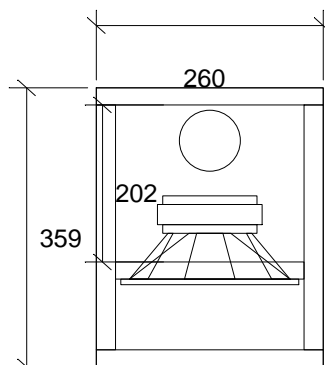
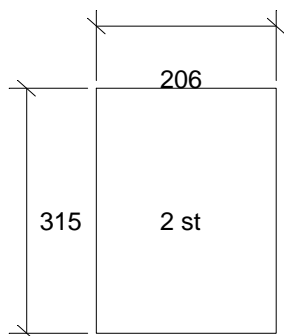

# Genererat av ProBox 2000

Programmet från Backe & Johan

Beräkningen gjord av: David Fock på MDS AB 2005-06-10

Fabrikat: MDS

Vb1: 9 liter

Modell: MDS FD8 8 tum

Vb2: 5 liter

Antal: 1

F-3dB: 38 Hz

Qts: .357

Fb1: 38 Hz

Vas: 16.983 liter

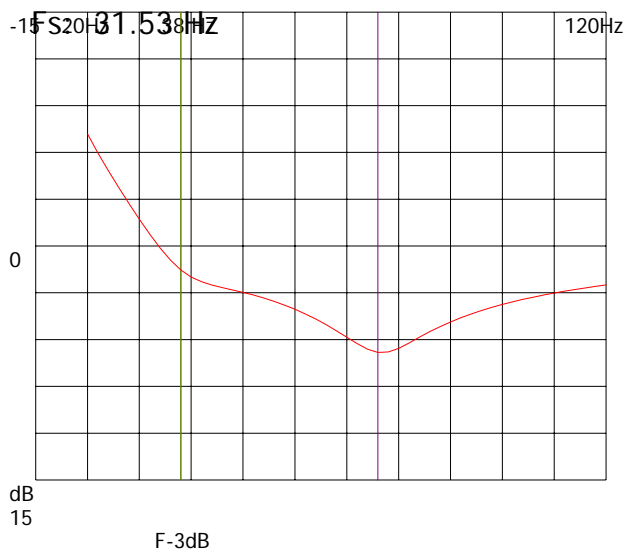

Portdia1: 7 cm

Antal: 1

Längd: 11 cm

Schematisk skiss lådtype: 5é ord. Hifi låda

(eventuellt fel antal högtalare.)

Biltyp: Golf storlek

Musiktyp: Allt

62% Funktion Spl: 120dB

