

2005-06-10  
126 35 Hägersten  
Midsommarv. 8-10  
MDS AB. David Fock  
Högtalare MDS MDS FD8  
F-3dB vid 39.2Hz materialtjocklek 22mm  
i stora kammaren Spl: 125dB  
2-kammarlåda 2 rör 120x ø70 mm

av Johan Lindberg.  
Backlunds Ljudbyggeri. Programmering  
Ritningen gjord med ProBox 2000 från

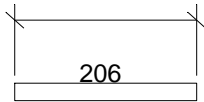

Djup 446

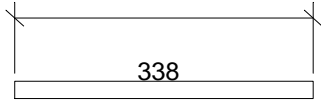

Djup 490

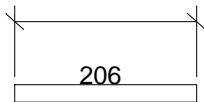

Djup 490

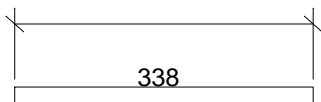

Djup 490

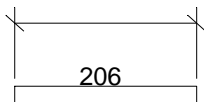

Djup 490

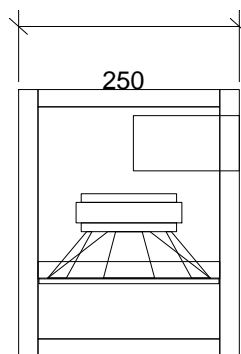
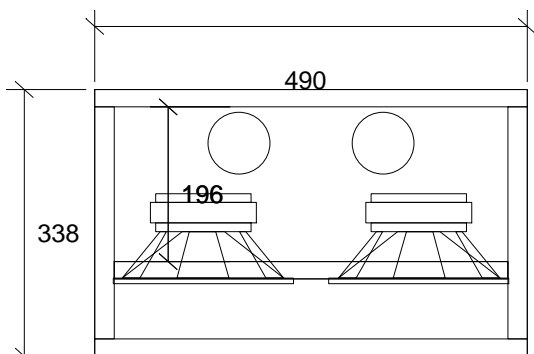
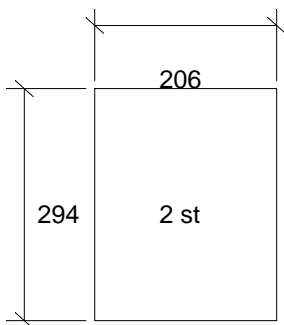

# Genererat av ProBox 2000

Programmet från Backe & Johan

Beräkningen gjord av: David Fock på MDS AB 2005-06-10

Fabrikat: MDS

Vb1: 18 liter

Modell: MDS FD8 8 tum

Vb2: 9 liter

Antal: 2

F-3dB: 39.2 Hz

Qts: .357

Fb1: 39 Hz

Vas: 16.983 liter

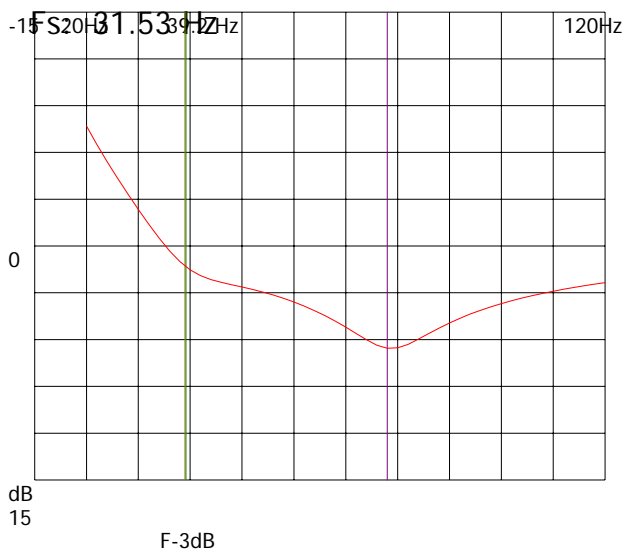

Portdia1: 7 cm

Antal: 2

Längd: 12 cm

Schematisk skiss lådtype: 5é ord. Hifi låda

Biltyp: Golf storlek

Musiktyp: Allt

(eventuellt fel antal högtalare.)

62% Funktion Spl: 125dB

