

2008-08-13
254 66
Garnisonsgatan 10
MDS Helsingborg. Jan Pålsson
Högtalare MDS FRR10
F-3dB vid 46Hz materialtjocklek 19mm
.91 Spl: 125dB
Sluten låda totalvolym 58l. Qtc=

av Johan Lindberg.
Backlunds Ljudbyggeri. Programmering
Ritningen gjord med ProBox 2000 från

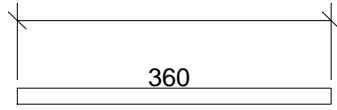

Djup 800

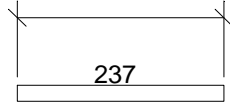

Djup 800

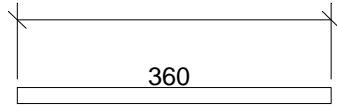

Djup 800

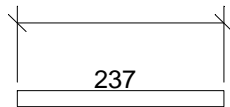

Djup 800

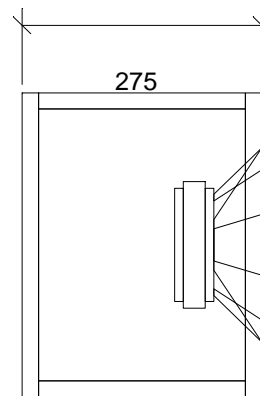
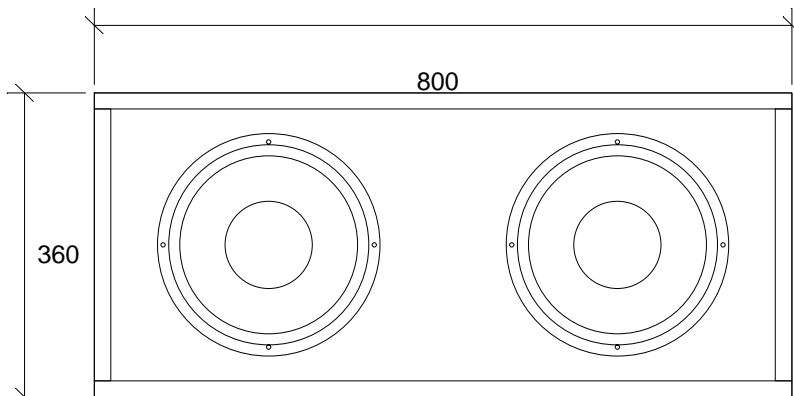
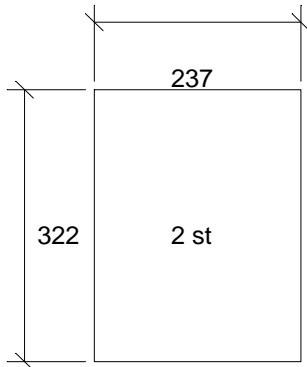

Genererat av ProBox 2000

Programmet från Backe & Johan

Beräkningen gjord av: Jan Pålsson på MDS Helsingborg 2008-08-13

Fabrikat: MDS

Vb1: 58 liter

Modell: FRR10 10 tum

Antal: 2

F-3dB: 46 Hz

Qts: .589

Fb1: 42 Hz

Vas: 40.55 liter

Qtc: .91

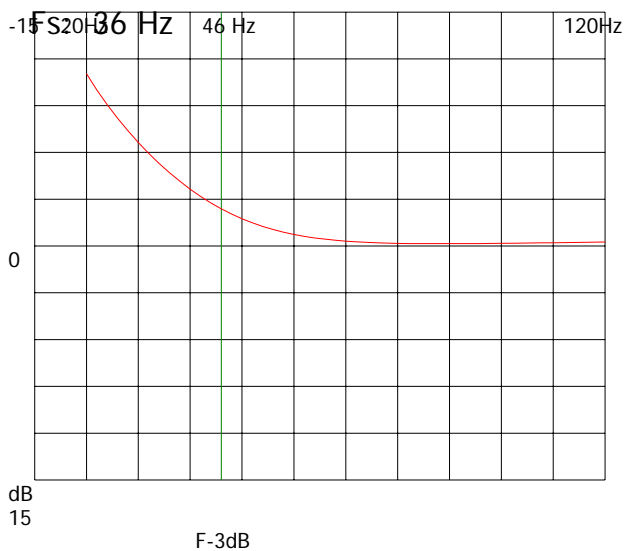

Beräknad fskematisk skiss lådtype: Sluten

(eventuellt fel antal högtalare.)

Egen F-3db frekvens

Musiktyp: Allt

?% Funktion Spl: 125dB

