

2001-05-04
126 35 Hägersten
Midsommarvägen 8-10
MDS AB. David
Högtalare MDS1 FAN-12RN
F-3dB vid 55.4Hz materialtjocklek 19mm
1.01 Spl: 122dB
Sluten låda totalvolym 35l. Qtc=

av Johan Lindberg.
Backlunds Ljudbyggeri. Programmering
Ritningen gjord med ProBox 2000 från

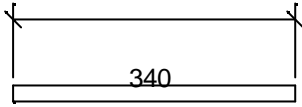

Djup 700

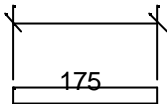

Djup 700

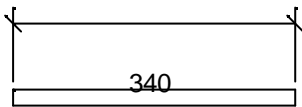

Djup 700

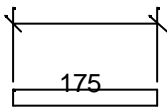

Djup 700

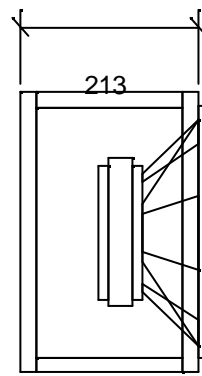
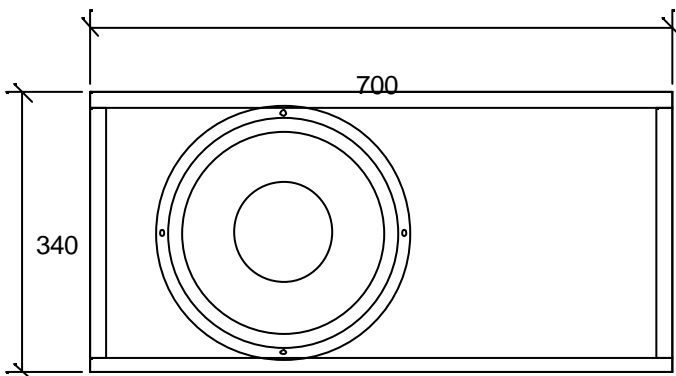
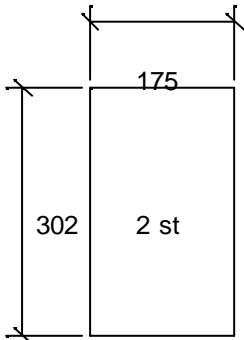

Genererat av ProBox 2000

Programmet från Backe & Johan

Beräkningen gjord av: David på MDS AB 2001-05-04

Fabrikat: MDS1

Vb1: 35 liter

Modell: FAN-12RN 12 tum

Antal: 1

F-3dB: 55.4 Hz

Qts: .55

Fb1: 48 Hz

Vas: 82 liter

Qtc: 1.01

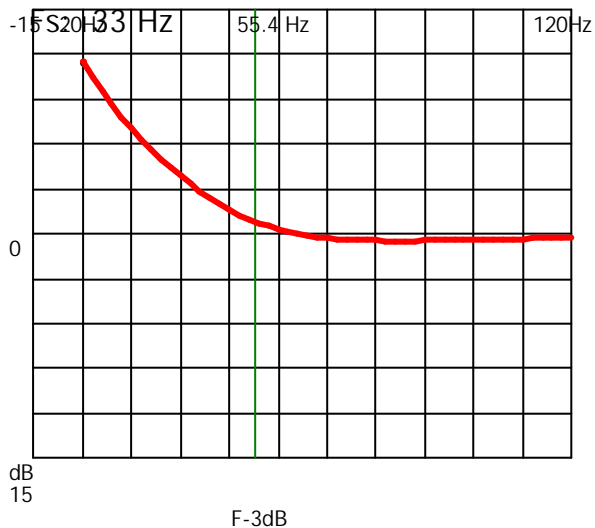

Schematisk skiss lådtype: Sluten

(eventuellt fel antal högtalare.)

Biltyp: Sedanbil

Musiktyp: Disco

73% Funktion Spl: 122dB

