

2009-03-06
254 66
Garnisonsgatan 10
MDS Helsingborg. Jan Pålsson
Högtalare MDS CFR12classic
F-3dB vid 42.6Hz materialtjocklek 19mm
ø103 mm. Spl: 125dB
Basreflex totalvolym 96l. 1 rör 130x

av Johan Lindberg.
Backlunds Ljudbyggeri. Programmering
Ritningen gjord med ProBox 2000 från

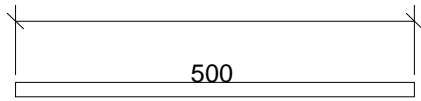

Djup 500

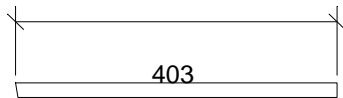

79°

Djup 500

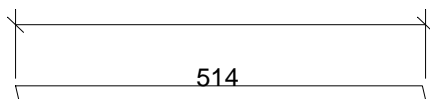

79°

Djup 500

79°

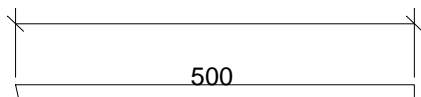

79°

Djup 500

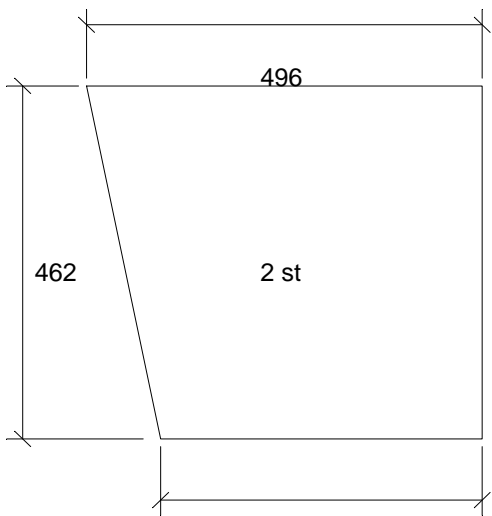

403

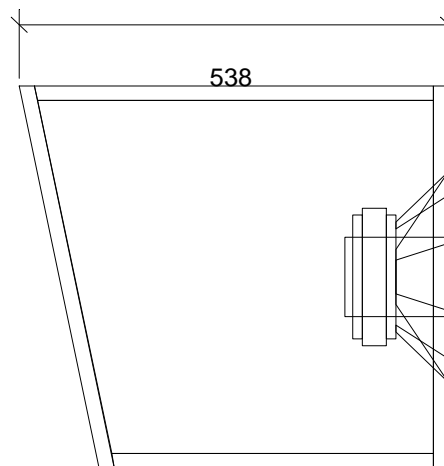
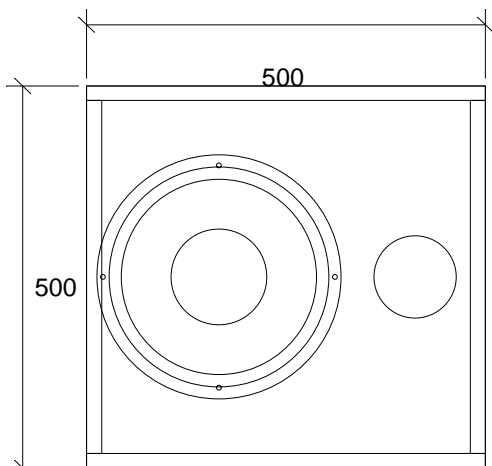

Genererat av ProBox 2000

Programmet från Backe & Johan

Beräkningen gjord av: Jan Pålsson på MDS Helsingborg 2009-03-06

Fabrikat: MDS

Vb1: 96 liter

Modell: CFR12classic 12 tum

Antal: 1

F-3dB: 42.6 Hz

Qts: .78

Fb1: 40 Hz

Vas: 127.3 liter

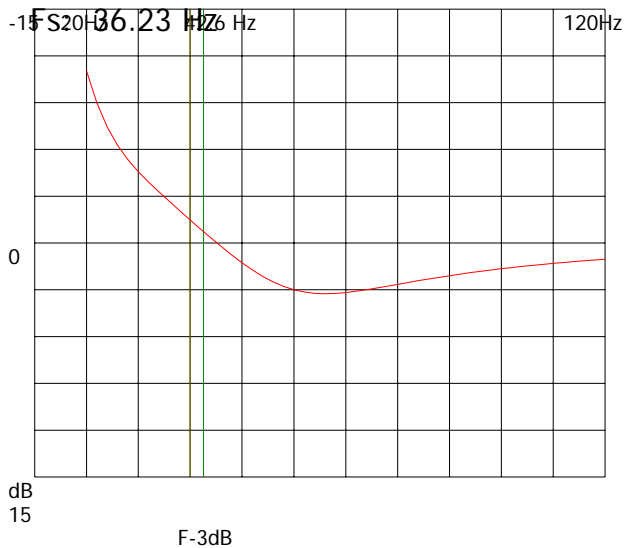

Portdia1: 10.3 cm

Antal: 1

Längd: 13 cm

Schematisk skiss lådtype: Basreflex

(eventuellt fel antal högtalare.)

Beräknad för litet rum

Musiktyp: Allt

50% Funktion Spl: 125dB

