

2001-04-18
126 35 Hägersten
Midsommarvägen 8-10
MDS AB. David
Högtalare MDS1 F10POW
F-3dB vid 46.3Hz materialtjocklek 19mm
ø70 mm. Spl: 122dB
Basreflex totalvolym 21l. 1 rör 160x

av Johan Lindberg.
Backlunds Ljudbyggeri. Programmering
Ritningen gjord med ProBox 2000 från

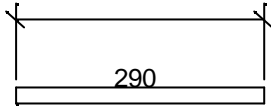

Djup 440

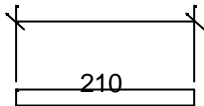

Djup 440

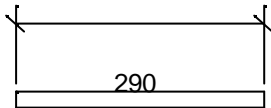

Djup 440

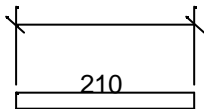

Djup 440

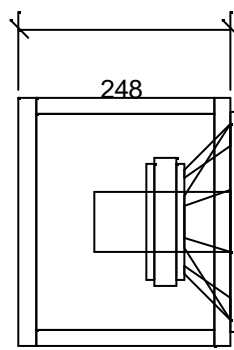
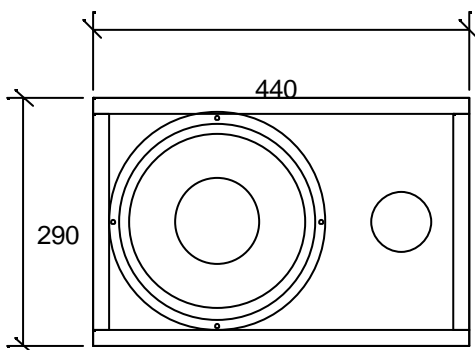
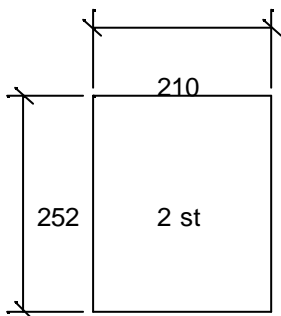

Genererat av ProBox 2000

Programmet från Backe & Johan

Beräkningen gjord av: David på MDS AB 2001-04-18

Fabrikat: MDS1

Vb1: 21 liter

Modell: F10POW 10 tum

Antal: 1

F-3dB: 46.3 Hz

Qts: .433

Fb1: 53 Hz

Vas: 21 liter

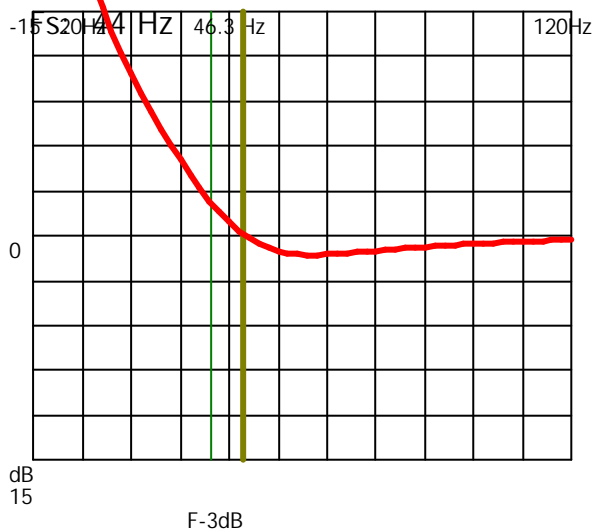

Portdia1: 7 cm

Antal: 1

Längd: 16 cm

Schematisk skiss lådtype: Basreflex

Egen F-3db frekvens

Musiktyp: Allt

(eventuellt fel antal högtalare.)

?% Funktion Spl: 122dB

